

Industrial Maintenance

Basic Controls

Courseware Sample

49409-F0

Order no.: 49409-10
First Edition
Revision level: 11/2017

By the staff of Festo Didactic

© Festo Didactic Ltée/Ltd, Quebec, Canada 2017
Internet: www.festo-didactic.com
e-mail: did@de.festo.com

Printed in Canada

All rights reserved

ISBN 978-2-89789-159-6 (Printed version)

ISBN 978-2-89789-161-9 (CD-ROM)

Legal Deposit – Bibliothèque et Archives nationales du Québec, 2017

Legal Deposit – Library and Archives Canada, 2017

The purchaser shall receive a single right of use which is non-exclusive, non-time-limited and limited geographically to use at the purchaser's site/location as follows.

The purchaser shall be entitled to use the work to train his/her staff at the purchaser's site/location and shall also be entitled to use parts of the copyright material as the basis for the production of his/her own training documentation for the training of his/her staff at the purchaser's site/location with acknowledgement of source and to make copies for this purpose. In the case of schools/technical colleges, training centers, and universities, the right of use shall also include use by school and college students and trainees at the purchaser's site/location for teaching purposes.

The right of use shall in all cases exclude the right to publish the copyright material or to make this available for use on intranet, Internet and LMS platforms and databases such as Moodle, which allow access by a wide variety of users, including those outside of the purchaser's site/location.

Entitlement to other rights relating to reproductions, copies, adaptations, translations, microfilming and transfer to and storage and processing in electronic systems, no matter whether in whole or in part, shall require the prior consent of Festo Didactic.

















Information in this document is subject to change without notice and does not represent a commitment on the part of Festo Didactic. The Festo materials described in this document are furnished under a license agreement or a nondisclosure agreement.

Festo Didactic recognizes product names as trademarks or registered trademarks of their respective holders.

All other trademarks are the property of their respective owners. Other trademarks and trade names may be used in this document to refer to either the entity claiming the marks and names or their products. Festo Didactic disclaims any proprietary interest in trademarks and trade names other than its own.

Safety and Common Symbols

The following safety and common symbols may be used in this manual and on the equipment:

Symbol	Description
	DANGER indicates a hazard with a high level of risk which, if not avoided, will result in death or serious injury.
	WARNING indicates a hazard with a medium level of risk which, if not avoided, could result in death or serious injury.
	CAUTION indicates a hazard with a low level of risk which, if not avoided, could result in minor or moderate injury.
	CAUTION used without the <i>Caution, risk of danger</i> sign  , indicates a hazard with a potentially hazardous situation which, if not avoided, may result in property damage.
	Caution, risk of electric shock
	Caution, hot surface
	Caution, risk of danger. Consult the relevant user documentation.
	Caution, lifting hazard
	Caution, belt drive entanglement hazard
	Caution, chain drive entanglement hazard
	Caution, gear entanglement hazard
	Caution, hand crushing hazard
	Notice, non-ionizing radiation
	Consult the relevant user documentation.
	Direct current

Safety and Common Symbols













Symbol	Description
	Alternating current
	Both direct and alternating current
	Three-phase alternating current
	Earth (ground) terminal
	Protective conductor terminal
	Frame or chassis terminal
	Equipotentiality
	On (supply)
	Off (supply)
	Equipment protected throughout by double insulation or reinforced insulation
	In position of a bi-stable push control
	Out position of a bi-stable push control

Table of Contents

Preface.....	XI
About This Manual.....	XIII
To the Instructor.....	XV
Unit 1	
Basic Principles of Motor Control.....	1
DISCUSSION OF FUNDAMENTALS.....	1
Control description.....	1
Safety procedure.....	2
Three-phase distribution systems.....	2
Ex. 1-1	
Lockout/Tagout Procedure.....	5
DISCUSSION.....	5
PROCEDURE.....	7
Equipment required.....	7
Basic setup.....	7
Line-neutral voltage.....	8
Line-line voltage.....	8
Lockout/Tagout procedure.....	9
Fuse replacement.....	9
Ex. 1-2	
Control Panel Devices.....	13
DISCUSSION.....	13
Push buttons.....	14
Selector and toggle switches.....	14
Pilot lights.....	15
PROCEDURE.....	16
Basic setup.....	16
Momentary contacts.....	17
Maintained contacts.....	19
Ex. 1-3	
Manual Starters.....	25
DISCUSSION.....	25
Direct-on-line (DOL) starters.....	25
Reversing starters.....	25
PROCEDURE.....	26
Basic setup.....	27
Direct-on-line (DOL) starter.....	27
Cam switch reversing circuit.....	29

Table of Contents

Ex. 1-4	Contactors and Control Relays	35
	DISCUSSION	35
	Contactors	36
	Control relays	37
	PROCEDURE	38
	Basic setup	38
	Contactor and control relay operation	39
	Dual contactors operation	41
	Mechanical interlock	43
Ex. 1-5	Current Protection Devices	47
	DISCUSSION	47
	Circuit breakers	48
	Fuses	48
	Overload protection	49
	PROCEDURE	52
	Basic setup	52
	Overload protection using the manual starter	52
	Overload protection using the overload relay	55
Unit 2	Circuit Layout and Specifications	67
	DISCUSSION OF FUNDAMENTALS	67
Ex. 2-1	Specifications Reading	69
	DISCUSSION	69
	Rating labels of control devices	69
	NEMA and IEC standards	70
	Pilot and control-circuit device rating	71
	Motor nameplate data and wiring information	74
	PROCEDURE	78
	Brake motor	79
	Contactor	80
	Control relay	81
Ex. 2-2	Symbols, Designations, and Diagrams	83
	DISCUSSION	83
	Wiring diagrams	84
	Schematic diagrams	85
	Graphic symbols	86
	Designations	86
	Target tables	87
	PROCEDURE	87

Table of Contents

Unit 3	Basic Control Circuits	101
	DISCUSSION OF FUNDAMENTALS.....	101
	Motor reversal	101
	Control voltage	101
	Brake motor.....	102
Ex. 3-1	Motor Starters	105
	DISCUSSION	105
	Inertia wheel.....	105
	Separate control.....	106
	PROCEDURE	107
	Basic setup.....	108
	Control transformer output voltage measurement	108
	Inrush current measurement.....	109
Ex. 3-2	Two-Wire and Three-Wire Controls	113
	DISCUSSION	113
	Two-wire control.....	113
	Three-wire control	114
	PROCEDURE	115
	Basic setup.....	115
	Two-wire control circuit	116
	Three-wire control circuit.....	117
Ex. 3-3	Manual Reversing Starters	121
	DISCUSSION	121
	PROCEDURE	122
	Basic setup.....	122
	Reversing the rotation direction by manually changing the line sequence	122
	Reversing the rotation direction using a cam switch to change the line sequence	124
Ex. 3-4	Reversing Starters	127
	DISCUSSION	127
	Push button interlocking.....	127
	Mechanical interlocking.....	128

Table of Contents

	PROCEDURE	130
	Basic setup.....	130
	Push button interlocking.....	130
	Mechanical interlocking.....	133
	Reversing starter with push button and mechanical interlock.....	134
Ex. 3-5	Multiple Push Buttons.....	139
	DISCUSSION	139
	PROCEDURE	140
	Basic setup.....	141
	Multiple push button circuit.....	141
	Emergency button	142
Unit 4	Jogging Control Circuits	147
	DISCUSSION OF FUNDAMENTALS.....	147
	Friction brakes.....	148
Ex. 4-1	Friction Brakes.....	149
	DISCUSSION	149
	PROCEDURE	151
	Basic setup.....	151
	Brake torque calculation.....	151
	Brake coil testing.....	153
	Motor stopping with and without friction brake.....	155
Ex. 4-2	Motor Starters with Jogging.....	159
	DISCUSSION	159
	Jog/Run circuits.....	159
	PROCEDURE	161
	Basic setup.....	161
	Simple jogging circuit	161
	Jog/Run circuit with selector switch	162
	Additional exercise	164
	Jog/Run circuit using a control relay	164
Ex. 4-3	Reversing Starters with Jogging	167
	DISCUSSION	167

Table of Contents

	PROCEDURE	170
	Basic setup.....	170
	Reversing starter with jogging circuit using push buttons and a control relay.....	170
	Additional exercise	173
	Jog/Run reversing circuit using a selector switch	173
Unit 5	Reduced AC Voltage Starters.....	179
	DISCUSSION OF FUNDAMENTALS.....	179
	The need for reduced current starting.....	179
	Typical starting methods	180
Ex. 5-1	Primary Resistor Starters	181
	DISCUSSION	181
	PROCEDURE	182
	Basic setup.....	183
	Brake motor locked rotor current without resistors	183
	Brake motor locked rotor current with resistors	185
	Motor power line voltage with primary resistors.....	186
	Motor power line voltage without primary resistors.....	187
Ex. 5-2	Soft Starters	191
	DISCUSSION	191
	PROCEDURE	194
	Basic setup.....	195
	Starting voltage setting	195
	Ramp-up time setting	196
	Ramp-down time setting	197
Unit 6	Time Relay Circuits	203
	DISCUSSION OF FUNDAMENTALS.....	203
Ex. 6-1	Time Relays.....	205
	DISCUSSION	205
	PROCEDURE	208
	Basic setup.....	209
	On-delay function	209
	Off-delay function	210
	On- and Off-delay function.....	211
	Flashing.....	212

Table of Contents

Ex. 6-2	Plugging with Time Relays	215
	DISCUSSION	215
	PROCEDURE	216
	Basic setup.....	217
	Manual plugging.....	217
	Plugging using a time relay.....	218
Ex. 6-3	Primary Resistor Starters with Time Relays	223
	DISCUSSION	223
	PROCEDURE	224
	Basic setup.....	224
	Primary resistor starter with time relay circuit	225
Appendix A	Equipment Utilization Chart	231
Appendix B	Diagram Symbols	233
Appendix C	Motor Frames Charts	237
Appendix D	Basic Setup and Lockout/Tagout Procedures.....	239
	Basic setup procedure	239
	Lockout/Tagout procedure (de-energizing procedure)	241
	Energizing procedure	242
	Module identification	243
Appendix E	Brake Motor, Inertia Wheel, and Safety Guard Installation ...	245
	Installation of the brake motor on the mounting plate.....	245
	Installation of the inertia wheel on the brake motor shaft	245
	Installation of the safety guard	247
Appendix F	Brake Motor Characteristics.....	249
Appendix G	Glossary	251
Appendix H	Fault Identification.....	255
	Bibliography	259

Preface

Control systems for electric motors are vital to the proper performance and protection of modern equipment. They are essentially the link in every complex industrial process. These systems may range from the simple starting and stopping of an electric motor to directing energy flow in a completely automated factory. Between these extremes, we find semiautomatic controllers in which a human operator must fill some of the required functions.

The Industrial Controls Training System, Model 8036, and the related modules and manuals, provide a thorough understanding of the theory and operation of electric motor controllers. Many genuine industrial components are included in the system to familiarize the student with the way they actually operate and special emphasis is put on safety.

Training starts with the basic fundamentals, and proceeds step by step, through various types of controls encountered in industry. The student manual explains what kinds of controls are available, how they operate, where they are used, and why they are used in a particular application.

The multiplicity of modules makes it possible to implement setups that fit a large number of needs. Control equipment and components are panel mounted with hidden fault insertion switches in each module to develop the troubleshooting skills of the students.

This program is fully compatible with existing modular components from our company.

We invite readers of this manual to send us their tips, feedback, and suggestions for improving the book.

Please send these to did@de.festo.com.

The authors and Festo Didactic look forward to your comments.

About This Manual

The exercises in this manual, Basic Controls, provide a foundation for further study in the industrial control branch of knowledge. Additional material is supplied in the following volumes of this series.

The present manual is divided into six units:

- Unit 1 provides basic safety procedures and presents most modules that will be used in this manual;
- Unit 2 gives an overview of the data that can be found on industrial control devices. This Unit also introduces graphical tools used to represent industrial control circuits;
- Unit 3 presents basic motor starters and control circuits;
- Unit 4 is dedicated to jogging and braking features of a control circuit;
- Unit 5 shows methods of starting a motor smoothly;
- Unit 6 introduces time relays.

Each unit contains exercises which provide a systematic and realistic means of learning the subject matter. Every exercise is divided into the following sections:

- A clearly defined Exercise Objective;
- A Discussion of the theory involved in the exercise;
- A Procedure Summary which provides a bridge between the theoretical Discussion and the laboratory Procedure;
- A step-by-step laboratory Procedure in which the student observes and quantifies important principles covered in the Discussion;
- A Conclusion to summarize the material presented in the exercise;
- Review Questions to verify that the material has been well assimilated.
- A ten-question test at the end of each unit allows the student's knowledge of the unit material to be assessed.

Safety considerations

Safety symbols that may be used in this manual and on the equipment are listed in the Safety and Common Symbols table at the beginning of the manual.

Safety procedures related to the tasks that you will be asked to perform are indicated in each exercise.

Make sure that you are wearing appropriate protective equipment when performing the tasks. You should never perform a task if you have any reason to think that a manipulation could be dangerous for you or your teammates.

About This Manual

Component specifications

A CD-ROM containing detailed specifications of the components is supplied in the back cover of this manual.

To the Instructor

You will find in this Instructor Guide all the elements included in the Student Manual together with the answers to all questions, results of measurements, graphs, explanations, suggestions, and, in some cases, instructions to help you guide the students through their learning process. All the information that applies to you is placed between markers and appears in red.

Before a student begins an exercise, ensure that the equipment is in good condition and does not represent any risk when used.

Make sure that the students understand the objectives of the work to do.

Accuracy of measurements

The numerical results of the hands-on exercises may differ from one student to another. For this reason, the results and answers given in this manual should be considered as a guide. Students who correctly performed the exercises should expect to demonstrate the principles involved and make observations and measurements similar to those given as answers.

Samples
Extracted from
Instructor Guide

Reversing Starters

EXERCISE OBJECTIVE

- Implement magnetic reversing starters.
- Understand the principles of mechanical and electrical interlocking.

DISCUSSION OUTLINE

The Discussion of this exercise covers the following points:

- Push button interlocking
- Mechanical interlocking

DISCUSSION

As you have seen in the previous exercise, reversing rotation direction of a three-phase motor is usually done by interchanging any two power lines. When the equipment is sufficiently rugged, motor line reversal can be accomplished while the motor is running at full speed. This has a major advantage: a counter torque is developed and the motor stops faster. This motor braking method is called **plugging**.

When phase reversal is executed in magnetic circuits, one contactor is used for each direction. But a short-circuit can occur if the two contactors are energized at the same time. Look at the power circuit in Figure 3-9, for example. If all contacts of the F and R contactors close, lines 1 and 2 will be short-circuited. That is the reason why forward and reverse contactors are usually electrically and/or mechanically interlocked together.

Push button interlocking

Avoiding simultaneous actuation of two contactors can be done electrically, by way of push button interlocking.

When the FWD push button in Figure 3-9 is pressed, the coil (F) is energized and the related holding contact closes. If the REV push button is pressed while the motor is running in the forward direction, the forward control circuit de-energizes. At the same time, the reverse contactor (R) is energized and held closed, making the motor run in the reverse direction. Note that it is not necessary to press the STOP push button to reverse the direction. This fact facilitates plugging.

If the FWD and REV push buttons are simultaneously activated, both contactors will stay open. That is because the push button NC contacts open the control circuit completely, thereby forcing contactor coils to de-energize.

However, if a contactor coil is stuck closed or does not open fast enough, there can still be a short-circuit when the other coil is activated.

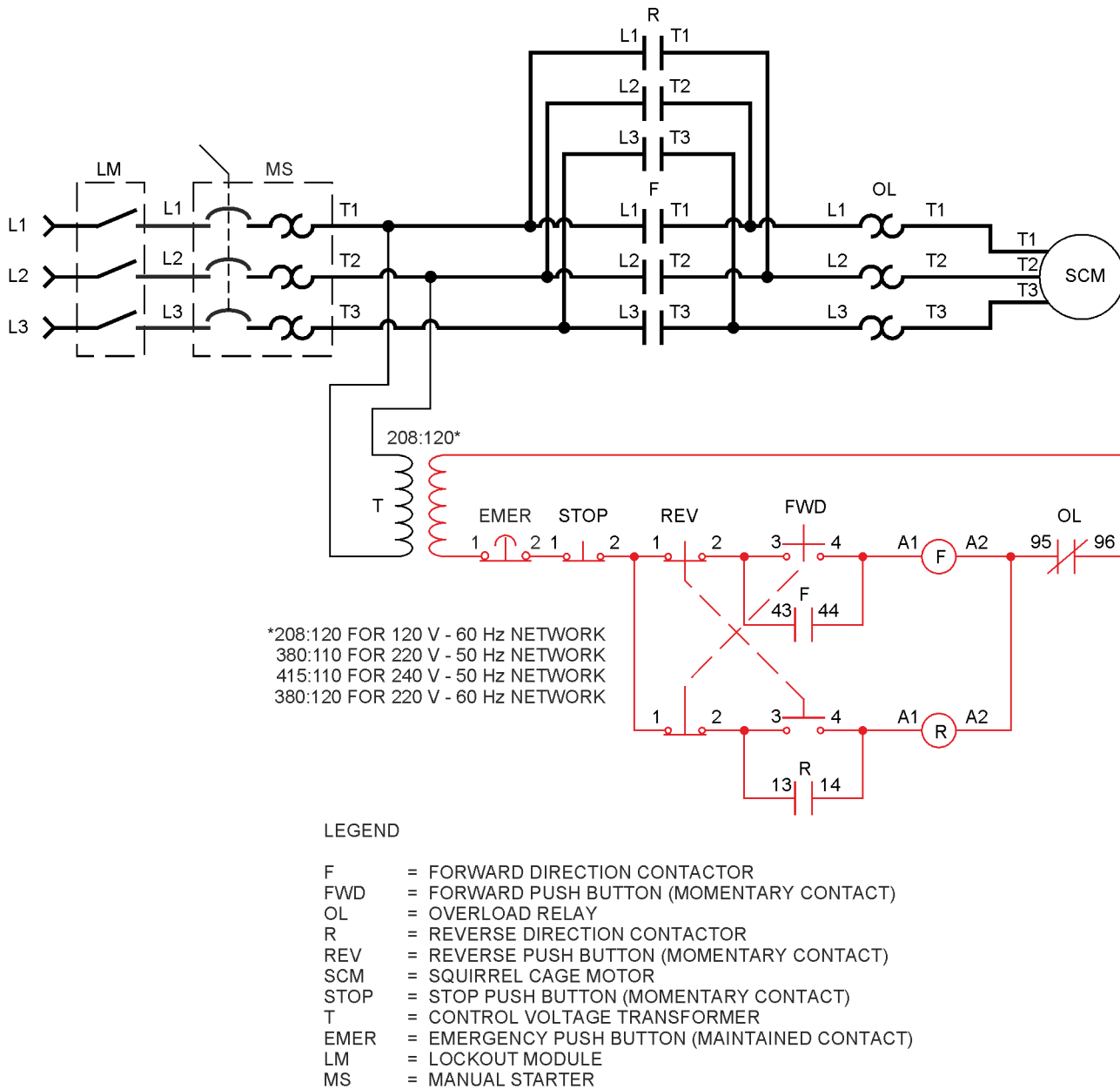

Figure 3-9. Push button interlocking circuit.

Mechanical interlocking

A mechanical lever is another manner of preventing both starter coils from being energized simultaneously. Figure 3-10 displays the mechanical interlock located between the two contactors of the Dual Contactors, Model 3119.

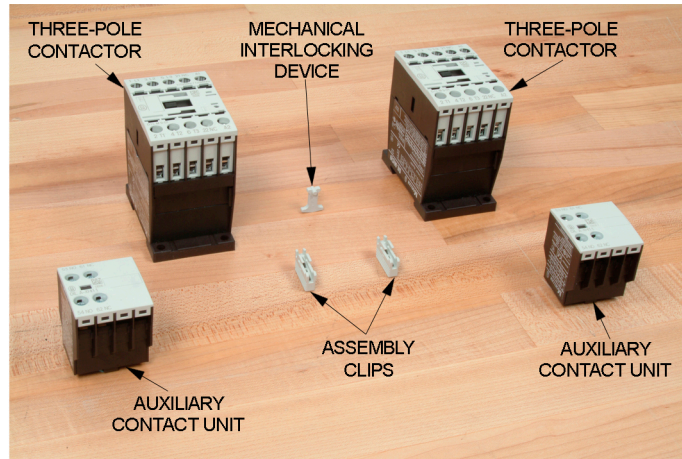
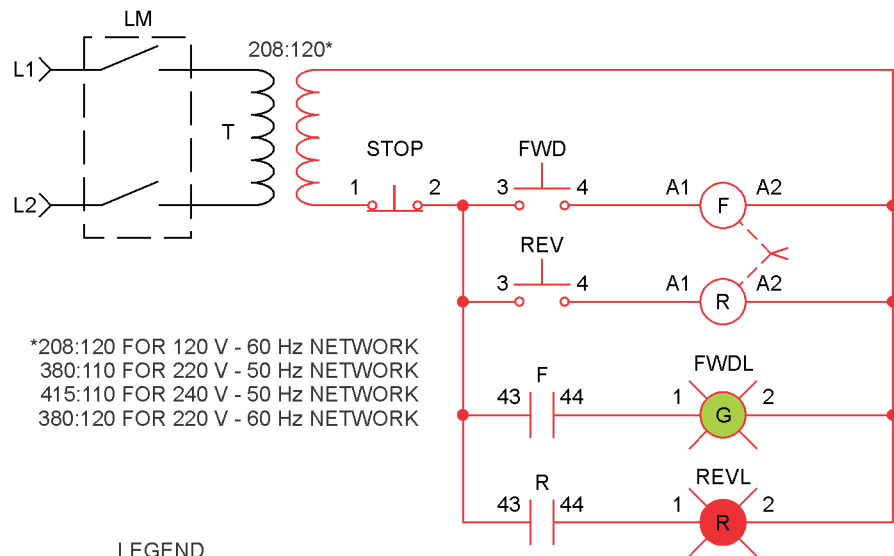

Figure 3-10. Mechanical interlocking.

Refer to the circuit of Figure 3-11. A mechanical interlock (in dashed lines) is located between the two contactor coils. When one of the two contactors is energized, the contacts of the other contactor are mechanically maintained, even if the second coil is energized. This method provides a level of security against short-circuits resulting from stuck contactors. This explains why mechanical interlocks are so common in the industry.



*208:120 FOR 120 V - 60 Hz NETWORK
 380:110 FOR 220 V - 50 Hz NETWORK
 415:110 FOR 240 V - 50 Hz NETWORK
 380:120 FOR 220 V - 60 Hz NETWORK

LEGEND

- F = FORWARD DIRECTION CONTACTOR
- FWD = FORWARD PUSH BUTTON (MOMENTARY CONTACT)
- FWDL = FORWARD PILOT LIGHT
- R = REVERSE DIRECTION CONTACTOR
- REV = REVERSE PUSH BUTTON (MOMENTARY CONTACT)
- REVL = REVERSE PILOT LIGHT
- STOP = STOP PUSH BUTTON (MOMENTARY CONTACT)
- T = CONTROL VOLTAGE TRANSFORMER
- LM = LOCKOUT MODULE

Figure 3-11. Dual contactors testing circuit.

PROCEDURE OUTLINE

The Procedure is divided into the following sections:

- Basic setup
- Push button interlocking
- Mechanical interlocking
- Reversing starter with push button and mechanical interlock

PROCEDURE

In the first part of this exercise, you will set up a reversible starter circuit with push button interlocking and verify that this circuit enables changing the motor direction. You will also observe that motor direction reversing can be accomplished without having to press the STOP push button, to stop the motor faster. You will then verify that both contactors remain de-energized if the operator accidentally presses the two push buttons. Finally, you will simulate a stuck contactor to see that push button interlocking does not protect against short-circuits resulting from that type of trouble.

In the second part of this exercise, you will study, with the assistance of pilot lights, how a mechanical interlock operates. By manually applying pressure on the dual contactors plungers, you will check that it is not possible to activate both contactors at the same time. You will then visualize that, when both coils are powered, only the first contactor has its related contacts closed.

In the last part of this exercise, you will connect a reversing starter with push button and mechanical interlocks. You will see that this circuit, like the push button interlock circuit, enables motor direction reversal and opens completely when both push buttons are pressed. You will also discover that the mechanical interlock included adds protection against stuck contactors.

WARNING



The AC Power Supply provides high voltages. Do not change any AC connection with the power on.

Basic setup

1. Perform the Basic Setup and Lockout/Tagout procedures.

Push button interlocking

2. Install the Brake Motor, Inertia Wheel, and Safety Guard.

Connect the circuit shown in Figure 3-9.



Use one of the two contactors from the Dual Contactors, Model 3119, as the forward direction contactor, and the Contactor, Model 3127, as the reverse direction contactor, to make sure that there is no mechanical link between contactors.

3. On the Manual Starter, set the overload potentiometer according to the motor FLA, and the O/I button to the I position.

Manually disengage the friction brake.

Perform the Energizing procedure.

Determine the motor rotation direction as you press the FWD push button.

- Clockwise Counterclockwise

Clockwise

4. Press the STOP push button and observe the time taken by the motor to stop.

5. Determine the motor rotation direction as you press the REV push button.

- Clockwise Counterclockwise

Counterclockwise

6. Compared to the forward operation, does the motor turn in the other direction?

- Yes No

Yes



The contactors are all AC-4 rated. This class allows for plugging operation (reversing direction of rotation from other than off condition).

7. While the motor is running in the reverse direction, press the FWD push button until the motor halts. Press the STOP push button before the motor starts rotating in the opposite (forward) direction. Repeat if necessary.



Repeated motor starts and stops may cause the Overload Relay to trip.

Did the motor stop slower or faster than with the STOP push button only?

- Slower Faster

Faster

8. When the FWD push button was pressed, why were both contactors (F and R) not activated at the same time, thereby causing a short-circuit?

Push button interlocking. Pressing the FWD push button opens the reverse holding contact R and closes the forward holding contact F.

9. What happens when you keep the FWD and REV push buttons pressed simultaneously?

The motor de-energizes. The result is the same as pressing the STOP push button.

10. Describe how the circuit operates while you simultaneously keep the FWD and REV push buttons pressed.

When the FWD and REV push buttons are pressed simultaneously, the NC contact of both directions opens.

11. What happens if you do not release both push buttons simultaneously? Explain why.

The motor will restart. The last push button that is released causes the motor to start in the corresponding direction.

12. Press the FWD push button to start the motor.

To simulate a stuck contactor, manually hold the forward contactor plunger down (using the tip of a pen), then press the REV push button. What happens?

The breakers in the Manual Starter trip.

13. Describe how the circuit operates while you simultaneously hold the forward contactor plunger down and press the REV push button.

A short-circuit is produced because the two contactors had their contacts closed simultaneously.

14. Does push button interlocking offer a good protection against stuck contactors?

Yes No

No

15. Perform the Lockout/Tagout procedure.

Mechanical interlocking

16. Connect the circuit shown in Figure 3-11.



Use the two contactors from the Dual Contactors module.

17. Perform the Energizing procedure.

18. Can you (manually) hold down completely the two contactor plungers simultaneously? Explain why.

No. There is a mechanical interlock between the two contactors.

19. When you press the FWD push button alone, which contactor coil is energized? (Refer to the respective pilot lights.)

F R

F

20. When you press the REV push button alone, which contactor coil is energized? (Refer to the respective pilot lights.)

F R

R

21. Does pressing the FWD and REV push buttons energize both contactor coils simultaneously?

Yes No

No

22. When both push buttons are pressed, which contactor coil(s) energize(s), in regard to the order in which the corresponding push buttons were pressed?

- The first The second Both None

The first

23. Perform the Lockout/Tagout procedure.

Reversing starter with push button and mechanical interlock

24. Connect the circuit shown in Figure 3-9, this time using the two contactors from the Dual Contactors module.

25. Perform the Energizing procedure.

Determine the motor rotation direction as you press the FWD push button.

- Clockwise Counterclockwise

Clockwise

26. Press the STOP push button and wait for the motor to stop.

27. Determine the motor rotation direction as you press the REV push button.

- Clockwise Counterclockwise

Counterclockwise

28. While the motor is running in the reverse direction, press the FWD push button. Does the motor direction change? Explain what happens, considering that the circuit now contains a mechanical interlock.

Yes. The push button interlock de-energizes the opposite direction contactor. Since only one coil is energized, the mechanical interlock does not react.

29. Press both push buttons simultaneously, and determine which contactor(s) energize(s), in regard to the order in which the corresponding push buttons were pressed.

- The first The second Both None

None

30. Press the FWD push button to start the motor. To simulate a stuck contactor, manually hold the forward contactor plunger down (using the tip of a pen). Press the REV push button.

Does the motor still run in the forward direction? Explain why.

Yes. There is now a mechanical interlock that prevents both contactors from being energized at the same time.

31. Does mechanical interlocking offer protection against stuck contactors?

- Yes No

Yes

32. Turn the individual power switch of the AC Power Supply off, disconnect the circuit, remove the magnetic labels, and return the equipment to the storage location.

CONCLUSION

Reversing magnetic starters are built with two contactors, one per rotation direction. If both contactors are actuated at the same time, a short-circuit can occur. This is why electrical and/or mechanical interlocks are used.

Push button interlocking is an electrical means of preventing two contactors from being actuated simultaneously. When a push button is pressed, the circuit controlling the other motor direction is automatically opened.

Mechanical interlocking uses a lever to artificially keep the second contactor de-energized, while the first coil is actuated. This method is more rugged in the way that it prevents short-circuits resulting from a stuck contactor.

Plugging is a method of making the motor brake faster. It is accomplished by reversing phases while the motor is running.

REVIEW QUESTIONS

1. What is the purpose of interlocking in reversing starters?
 - a. Prevent any contactor from being energized.
 - b. Prevent any contactor from being de-energized.
 - c. Stop the motor in case of electrical overload.
 - d. Prevent two contactor coils from being energized at the same time.

d

2. How many contactors are necessary for reversing starters?
 - a. 2
 - b. 3
 - c. 4
 - d. 5 or more

a

3. What is the motor braking method that uses the counter torque produced by reversing connections?
 - a. Inching
 - b. Plugging
 - c. Jogging
 - d. DC injection

b

4. In mechanical interlocking, which item prevents both coils from being actuated simultaneously?
- a. Coil
 - b. Lever
 - c. Push button
 - d. Diode

b

5. In the Figure 3-9 circuit, which lines have been interchanged in the reverse mode compared to the forward mode?
- a. Line 1 and line 2
 - b. Line 1 and line 3
 - c. Line 2 and line 3
 - d. Line 1 and line N

a

Bibliography

Rockis, G., and Glen Mazur. Electrical Motor Controls, Second Edition. Homewood, IL: American Technical Publishers Inc., 2001, ISBN 0826916759.

U.S. Department of Labor, Occupational Safety and Health Administration. Control of Hazardous Energy (Lockout/Tagout). 29 CFR 1910.147.

Wildi, T. Electrical Machines, Drives and Power Systems, Sixth Edition. Englewood Cliffs, NJ: Prentice Hall, 2005, ISBN 0131776916.

Herman, S.L. Industrial Motor Control, Fifth Edition. Clifton Park, NY: Thomson Delmar Learning, 2005, ISBN 1401838022.

National Electrical Manufacturers Association. NEMA and IEC Devices for Motor Services - A Guide for Understanding the Differences. ICS 2.4-2003.

National Electrical Manufacturers Association. Industrial Control and Systems: Diagrams, Device Designations, and Symbols. ICS 19-2002.

International Electrotechnical Commission. Graphical Symbols for Diagrams. IEC 60617.

National Center for Construction Education and Research. Electrical Level 3 Trainee Guide. Upper Saddle River, NJ: Pearson/Prentice Hall, 2002, ISBN 0130472239.